



FEATURES

- Comprehensive integration
- EAW Focusing
- U-Net (audio and communications network)
- EAW Pilot Control and communications
- 1500 watts of class leading power

APPLICATIONS

Corporate A/V, any small to medium sized live sound reinforcement, performing arts venues, houses of worship, retail, ballrooms, theaters, theme parks.

DESCRIPTION

The JFNT Series of comprehensively integrated 2-way sound reinforcement systems elevate the notion of power and utility. Each JFNT features premium neodymium components, 1500W of amplification, revolutionary EAW Focusing processing, EAW Pilot software-accessible front-end DSP, the proprietary U-Net audio and communications network and the JF Series adaptable enclosure design. All models natively offer a combination of portable features and M10 installation points. Available universal accessories include trim plates that hide handles and provide a connection point for u-brackets and quick release flytrack segments that integrate into any enclosure and adjustable legs for use as a stage monitor.

ORDERING DATA

Description	Part Number
EAW JF26NT Black Active Speaker 115 V	2034565-00
EAW JF26NT Black Active Speaker 230 V	2034565-01
Optional Accessories	
M10 × 37mm Forged Shoulder Eyebolt	0029818
EAW U-Bracket Adjustable S1 BLK [UBKT-S1]	2035474
EAW ACC Leg Adjustable S (2 Per) [ACC-LGS]	2035438
EAW ACC Flytrack S (2 Per) [ACC-FTS]	2035439
EAW ACC Cover Plate S (2 Per) BLK [ACC-CPS]	2035473
Fly Clip with Ring	0001386

COMPLIANCE:

CE	EN 60065:2002, EN55103-1:1997, EN 55103-2:1997, EN 55103-1, EN55103-2, EN60065
CSA	CAN/CSA 60065-03, UL Std No. 60065-03
FCC	Part 15

2-WAY SELF-POWERED LOUDSPEAKER 60° × 45°

See *NOTES TABULAR DATA* for details

CONFIGURATION

Subsystem:	Transducer	Loading
LF	1x 12 in cone	Vented
HF	1x 1.4 in exit, 3 in voice coil compression driver	Horn-loaded

Operating Mode:

Amplifier Channels	Signal Processing
Bi-amp LF, HF	DSP w/ EAW Focusing

ACOUSTICAL PERFORMANCE

Operating Range: 55 Hz to 20 kHz

Nominal Beamwidth:

Horz	60°
Vert	45°

Axial Output Limit (whole space SPL):

Calculated	Average	Peak
LF/HF	124 dB	130 dB

ELECTRICAL PERFORMANCE

Input

Type	Electronically balanced XLRF	
Sensitivity	2.5 V / 10 dBu at Limit	6.2 V / 18 dBu at Clip
Impedance	20 k ohm (balanced to chassis), 10 k ohm (unbalanced)	
Wiring	Pin 1: chassis, Pin 2: signal +, Pin 3: signal -	
Loop	Electronically balanced XLRM	

DSP (50 Mflop 32 bit Sharc):

Encoding	24 Bit / 48 kHz
Filters	Proprietary
Latency	2.97 ms

User Addressable DSP

Array	Box
EQ	10 Parametric
Delay	1200 ms
Level	15 dB +/-

Amplifier

	LF	HF
Type	Modified Class D	
Maximum Output	63 V, 1000 W @ 4 ohm	45 V, 500 W @ 4 ohm
THD + noise	< 0.3%	< 0.1%
Dynamic Range	> 105 dB	> 102 dB
Driver Protection	Integral DSP limiting	

AC Mains (Nominal)

	115 V	230 V
Connector	Neutrik PowerCon®	
Input	100 V to 120 V	220 V to 240 V
Frequency	50 Hz to 60 Hz	
Current:		
Idle	0.25 A	0.15 A
In Rush	0.9 A	0.6 A
Output Limit	1.6 A	1.0 A
Fuse Rating	10 A	6.3 A

Input Selection Analog, AES Ch 1, AES Ch 2, U-Net (1 - 64)

Communication USB, U-Net 1, U-Net 2

CONTROLS

High Pass Filter	55 Hz / 80 Hz / 110 Hz
Mode	Normal / Coupled / Monitor

INDICATORS (LED)

Signal Present	System Gain
Limiter Active	Rear Speaker DSP
Clip	Input Selection
Amplifier Status	U-Net Status

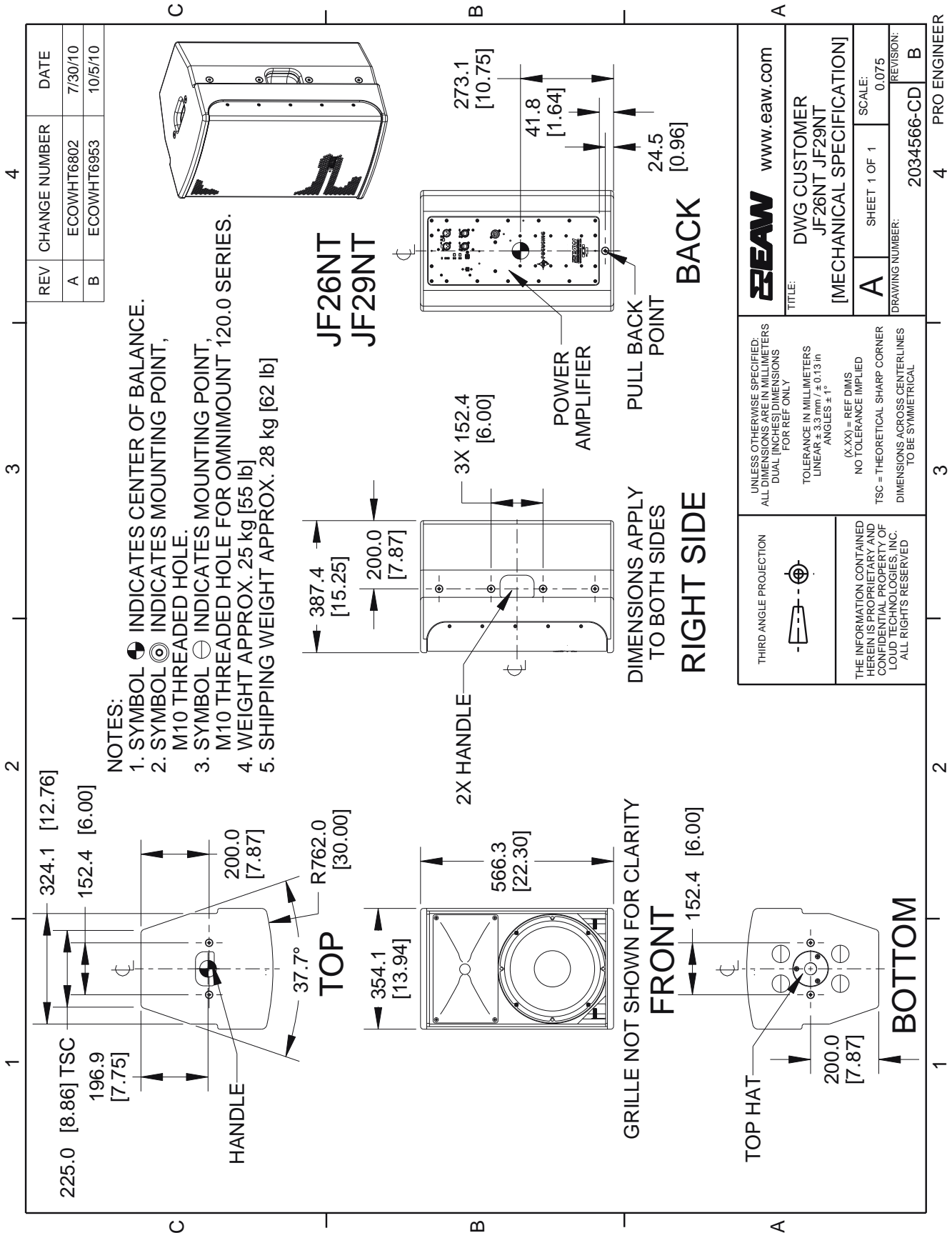

NOTE: This drawing has been reduced. Do not scale.

PERFORMANCE DATA

See *NOTES GRAPHIC DATA* for details

Frequency Response: Processed Multi-Amp

Complete = blue

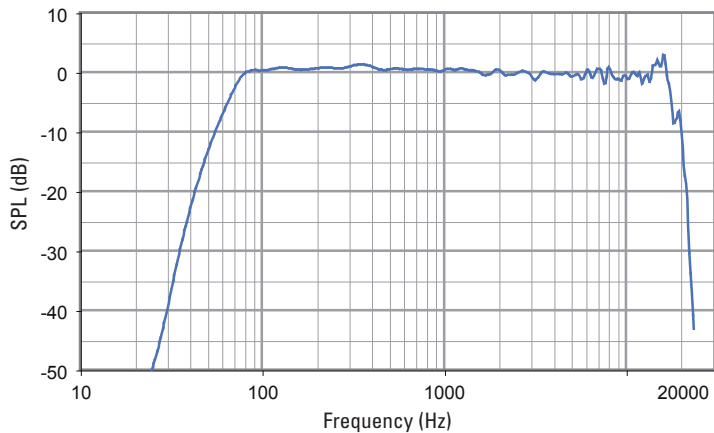

Phase Linearity

Complete = blue

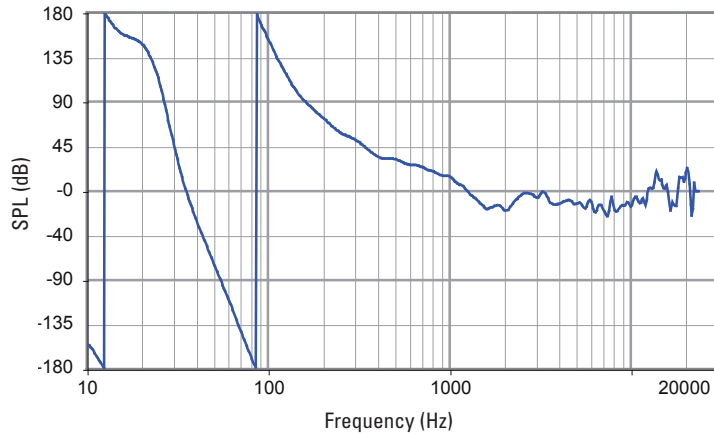

Beamwidth (-6 dB SPL Points)

Horizontal = orange Vertical = black

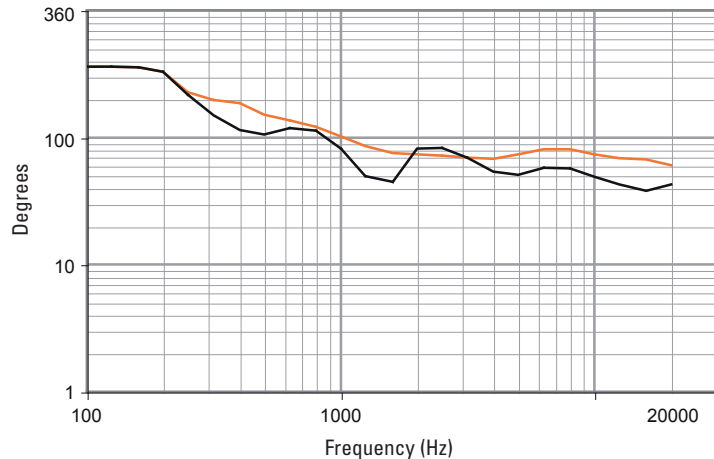

Directivity Index

Complete = pink

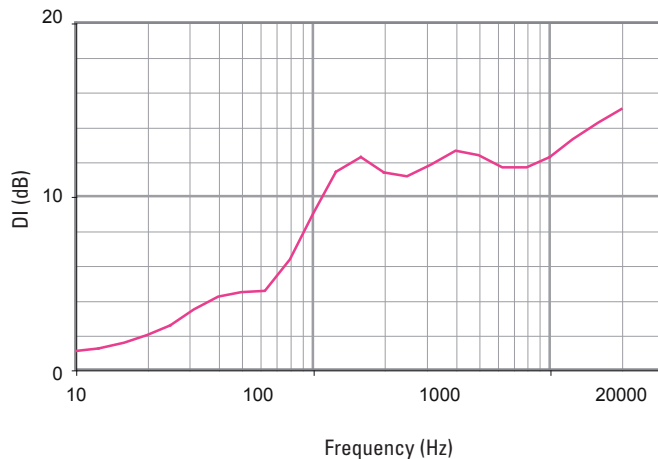

HORIZONTAL POLAR DATA

See *NOTES GRAPHIC DATA* for details

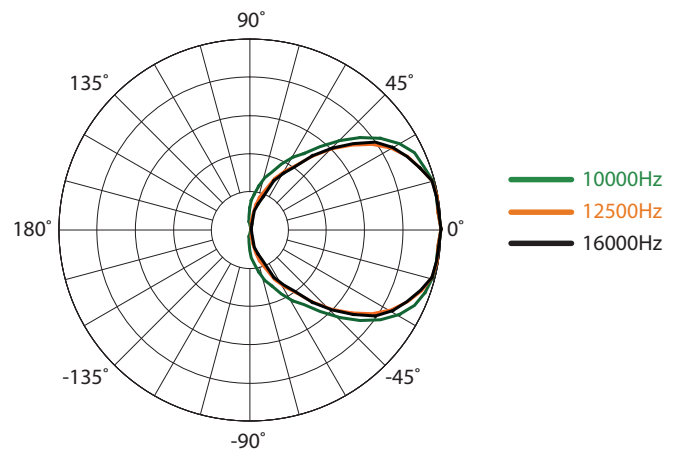
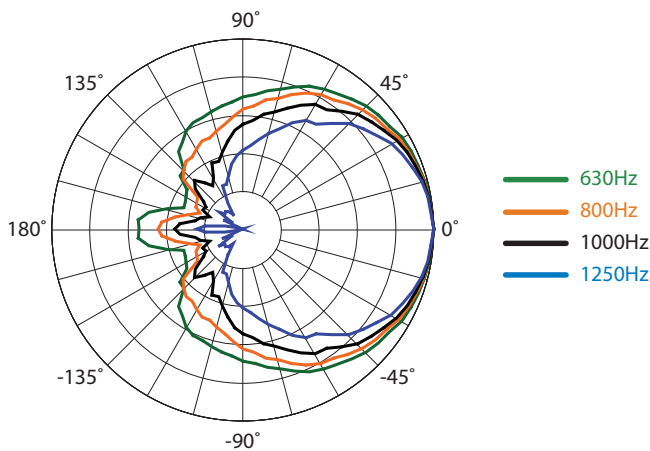
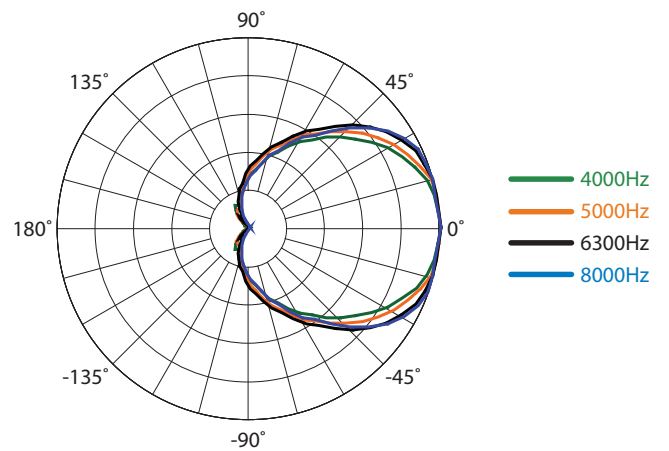
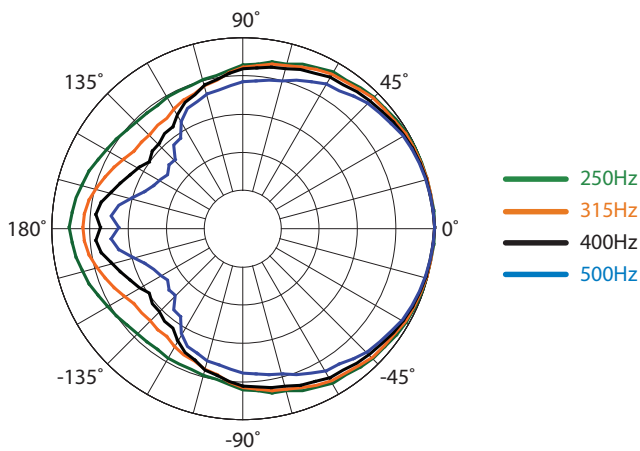
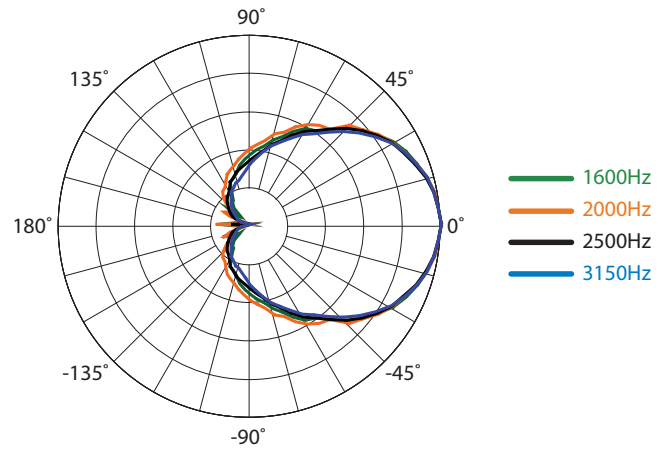
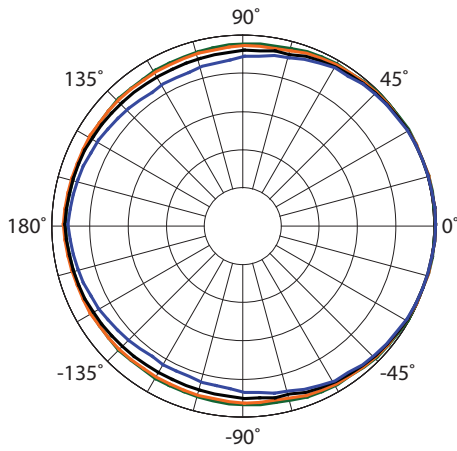

VERTICAL POLAR DATA

See *NOTES GRAPHIC DATA* for details

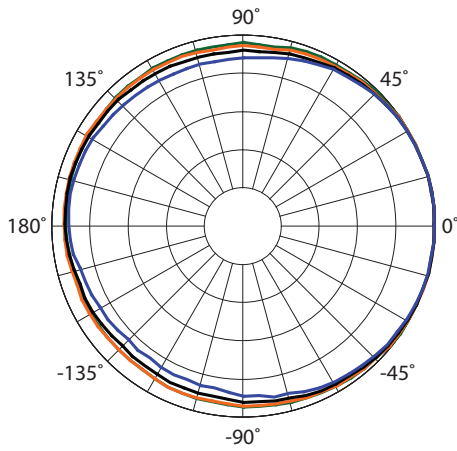

- 100Hz
- 125Hz
- 160Hz
- 200Hz

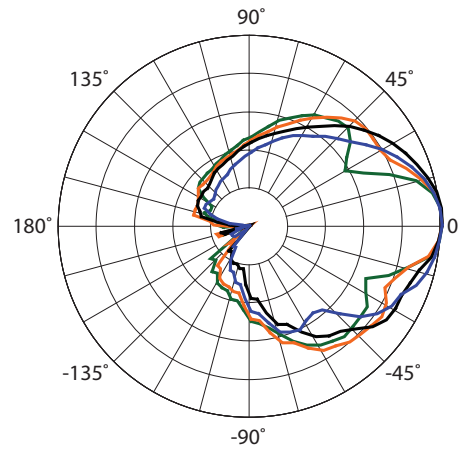

- 1600Hz
- 2000Hz
- 2500Hz
- 3150Hz

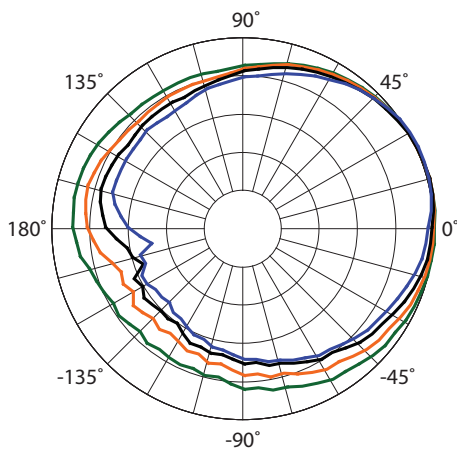

- 250Hz
- 315Hz
- 400Hz
- 500Hz

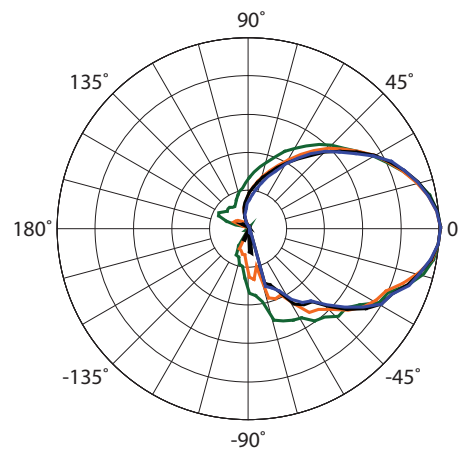

- 4000Hz
- 5000Hz
- 6300Hz
- 8000Hz

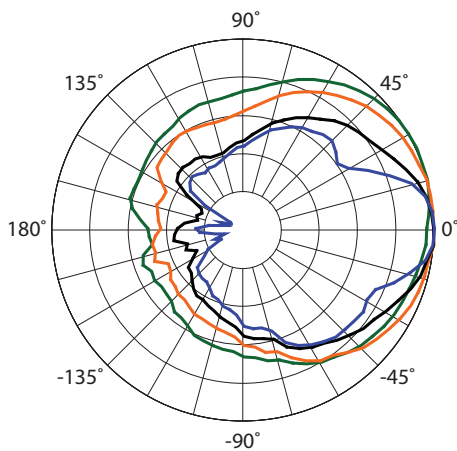

- 630Hz
- 800Hz
- 1000Hz
- 1250Hz

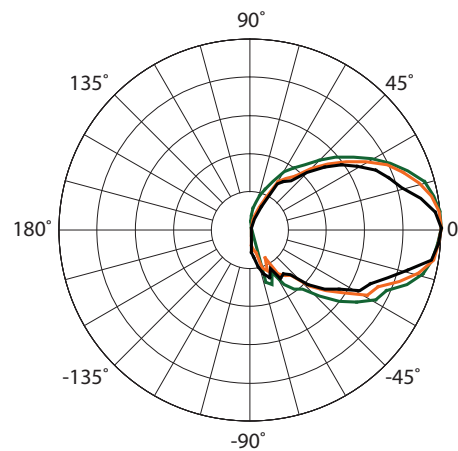

- 10000Hz
- 12500Hz
- 16000Hz

INPUT PANEL

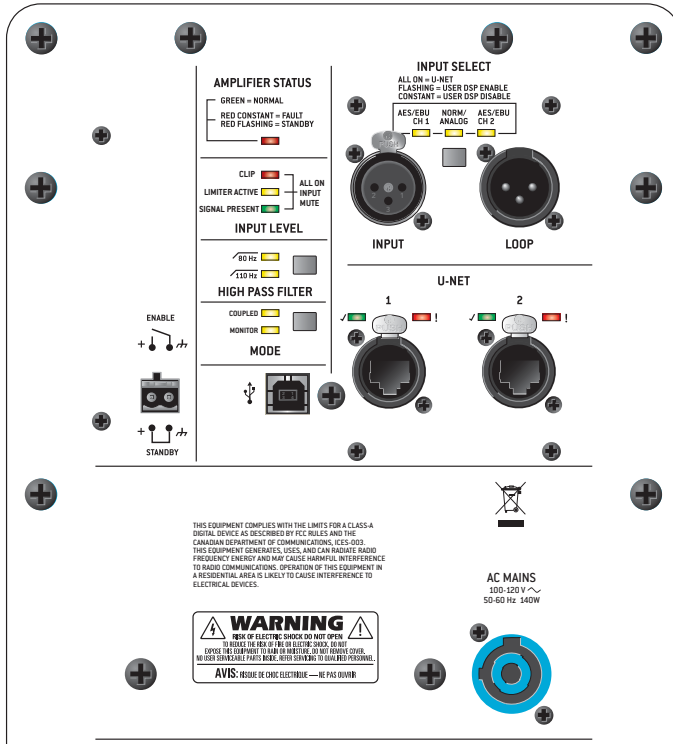

SIGNAL DIAGRAM

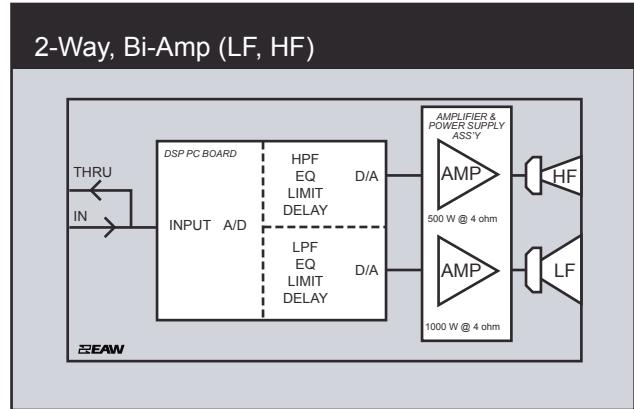

LEGEND

- DSP:** EAW UX8800 Digital Signal Processor –or– Integral Digital Signal Processing for NT products.
- HPF:** High Pass Filter for crossover –or– Recommended High Pass Filter.
- LPF:** Low Pass Filter for crossover.
- LF/MF/HF:** Low Frequency / Mid Frequency / High Frequency.
- AMP:** User Supplied Power Amplifier –or– Integral Amplifier for NT products.
- XVR:** Passive LPFs, HPFs, and EQ integral to the loudspeaker.
- EAW Focusing:** Digital Signal Processor capable of implementing EAW Focusing.

NOTES

TABULAR DATA

1. **Measurement/Data Processing Systems:** Primary - FChart: proprietary EAW software; Secondary - Brüel & Kjær 2012.
2. **Microphone Systems:** Earthworks M30; Brüel & Kjær 4133
3. **Measurements:** Dual channel FFT; length: 32 768 samples; sample rate: 48 kHz; logarithmic sine wave sweep.
4. **Measurement System Qualification** (includes all uncertainties): SPL: accuracy +/-0.2 dB @ 1 kHz, precision +/-0.5 dB 20 Hz to 20 kHz, resolution 0.05 dB; Frequency: accuracy +/-1 %, precision +/-0.1 Hz, resolution the larger of 1.5 Hz or 1/48 octave; Time: accuracy +/-10.4 µs, precision +/-0.5 µs, resolution 10.4 µs; Angular: accuracy +/-1°, precision +/-0.5°, resolution 0.5°.
5. **Environment:** Measurements time-windowed and processed to eliminate room effects, approximating an anechoic environment. Data processed as anechoic or fractional space, as noted.
6. **Measurement Distance:** 7.46 m. Acoustic responses represent complex summation of the subsystems at 20 m. SPL is referenced to other distances using the Inverse Square Law.
7. **Enclosure Orientation:** For beamwidth and polar specifications, as shown in Mechanical Specification drawing.
8. **Volts:** Measured rms value of the test signal.
9. **Watts:** Per audio industry practice, "loudspeaker watts" are calculated as voltage squared divided by rated nominal impedance. Thus, these are not True Watt units of energy as defined by International Standard.
10. **SPL:** (Sound Pressure Level) Equivalent to the average level of a signal referenced to 0 dB SPL = 20 microPascals.
11. **Subsystem:** This lists the transducer(s) and their acoustic loading for each passband. Sub = Subwoofer, LF = Low Frequency, MF = Mid Frequency, HF = High Frequency.
12. **Operating Mode:** User selectable configurations. Between system elements, a comma (,) = separate amplifier channels; a slash (/) = single amplifier channel. DSP = Digital Signal Processor. **IMPORTANT:** To achieve the specified performance, the listed external signal processing must be used with EAW-provided settings.
13. **Operating Range:** Range where the processed Frequency Response stays within -10 dB SPL of the power averaged SPL within this range; measured on the geometric axis. Narrow band clips are excepted.
14. **Nominal Beamwidth:** Design angle for the -6 dB SPL points, referenced to 0 dB SPL as the highest level.
15. **Axial Sensitivity:** Power averaged SPL over the Operating Range with an input voltage that would produce 1 W at the nominal impedance; measured with no external processing on the geometric axis, referenced to 1 m.
16. **Nominal Impedance:** Selected 4, 8, or 16 ohm resistance such that the minimum impedance point is no more than 20% below this resistance over the Operating Range.
17. **Accelerated Life Test:** Maximum test input voltage applied with an EIA-426B defined spectrum; measured with recommended signal processing and Recommended Protection Filter.
18. **Calculated Axial Output Limit:** Highest average and peak SPLs possible during the Accelerated Life Test. The Peak SPL represents the 2:1 (6 dB) crest factor of the Life Test signal.
19. **High Pass Filter:** This helps protect the loudspeaker from excessive input signal levels at frequencies below the Operating Range.

GRAPHIC DATA

1. **Resolution:** To remove insignificant fine details, 1/12 octave cepstral smoothing was applied to acoustic frequency responses and 1/3 octave cepstral smoothing was applied to the beamwidth and impedance data. Other graphs are plotted using raw data.
2. **Frequency Responses:** Variation in acoustic output level with frequency for a constant input signal. Processed: normalized to 0 dB SPL. Unprocessed inputs: 2 V (4 ohm nominal impedance), 2.83 V (8 ohm nominal impedance), or 4 V (16 ohm nominal impedance) referenced to a distance of 1 m.
3. **Processor Response:** The variation in output level with frequency for a constant input signal of 0.775 V = 0 dB reference.
4. **Beamwidth:** Average angle for each 1/3 octave frequency band where, starting from the rear of the loudspeaker, the output first reaches -6 dB SPL referenced to 0 dB SPL as the highest level. This method means the output may drop below -6 dB SPL within the beamwidth angle.
5. **Impedance:** Variation in impedance magnitude, in ohms, with frequency without regard to voltage/current phase. This means the impedance values may not be used to calculate True Watts (see 9 above).
6. **Polar Data:** Horizontal and vertical polar responses for each 1/3 octave frequency band 100 Hz to 16 kHz or Operating Range.