

3-WAY FULL-RANGE BI-AMP (passive MF/HF filter)

Performance is for a single KF730P. Array performance is determined using the KF730 Wizard.

See *TABULAR DATA* notes for details

CONFIGURATION

Subsystem

	<i>Transducer</i>	<i>Loading</i>
LF	2x 10 in cone	Phase Aligned™
MF	2x 7 in cone	Horn-loaded
HF	2x 1 in exit, 1.75 in voice coil neodymium compression driver	Horn-loaded

Operating Mode

	<i>Amplifier Channels</i>	<i>External Signal Processing</i>
Bi-amp	LF, MF/HF	DSP w/2-way filters

PERFORMANCE ¹

Operating Range 80 Hz to 20 kHz

Nominal Beamwidth

Horz	110°
Vert	12°

Axial Sensitivity (*whole space SPL*)

MF/HF	105 dB	230 Hz to 20 kHz
LF	91 dB	80 Hz to 230 Hz

Peak Sensitivity (*whole space SPL*)

MF/HF	112 dB	20 Hz to 20 kHz
LF	92 dB	20 Hz to 20 kHz

Input Impedance (*ohms*)

	<i>Nominal</i>	<i>Minimum</i>
MF/HF	16	15.9 @ 680 Hz
LF	16	15.1 @ 250 Hz

Recommended High Pass Filter

High Pass =>80 Hz, 24 dB/octave

Accelerated Life Test ²

MF/HF	75 V	350 W @ 16 ohm
LF	106 V	700 W @ 16 ohm

Calculated Axial Output Limit (*whole space SPL*)

	<i>Average</i>	<i>Peak</i>
MF/HF	130 dB	136 dB
LF	119 dB	125 dB

ORDERING DATA

<i>Description</i>	<i>Part Number</i>
KF730P Black Line Array Loudspeaker	0007663
KF730P White Line Array Loudspeaker	0009645
Optional Accessories	
KF730P/SB730P Fly-Bar	0008108
KF730P Pull-Bar	0008363

FEATURES

- Highest output to size ratio for small format line arrays
- Large MF/HF horn and Phase Aligned™ LF drivers for exceptional 110° horizontal pattern to 160 Hz
- KF730 Wizard auto-designs flown and ground-stacked arrays
- Included Splay Brackets fix the splay angles between enclosures
- 16 ohm inputs allow powering 8 KF730s with 2 amplifier channels

DESCRIPTION

The KF730P Series is a compact, fixed installation, line array system that sets a performance benchmark above similar systems. It delivers 3-way, KF Series performance in a flexible, easy-to-use system that can deliver concert-level output in an exceptionally wide range of venues. The KF730P is an excellent solution for fixed installation applications such as houses of worship, theatres, hotel ballrooms, arenas, and concert halls. The system is also ideal for supplemental coverage for larger line arrays, such as the KF760 Series. Such uses include audience side fill, delayed arrays for balconies, and stage/performer coverage.

One large MF/HF horn fills the entire face of the enclosure, better maintaining horizontal pattern control throughout the MF/HF passband. The curved aperture MF loading slots effectively move the MF acoustic origin further into the horn than physical space permits. The side-mounted LF drivers provide a forward-firing, figure eight type pattern. The drivers are spaced so that the LF beamwidth matches the MF through crossover.

The KF730P input features barrier strip terminals. A separate terminal strip is provided for loop-through connection for daisy-chaining additional KF730Ps. The KF730P is configured using the included KF730P Splay Angle Brackets to bolt the enclosures together. This rigging system is fully compatible with the companion SB730P subwoofer. Six year warranty.

¹ To achieve specified performance, the listed external signal processing with EAW-provided settings is required.

² For recommendations to select power amplifier size refer to: "HOW MUCH AMPLIFIER POWER DO I NEED?" on the EAW web site.

ENCLOSURE

Material	Baltic birch plywood
Finish	Wear resistant textured black paint
Grille	Powder-coated perforated steel

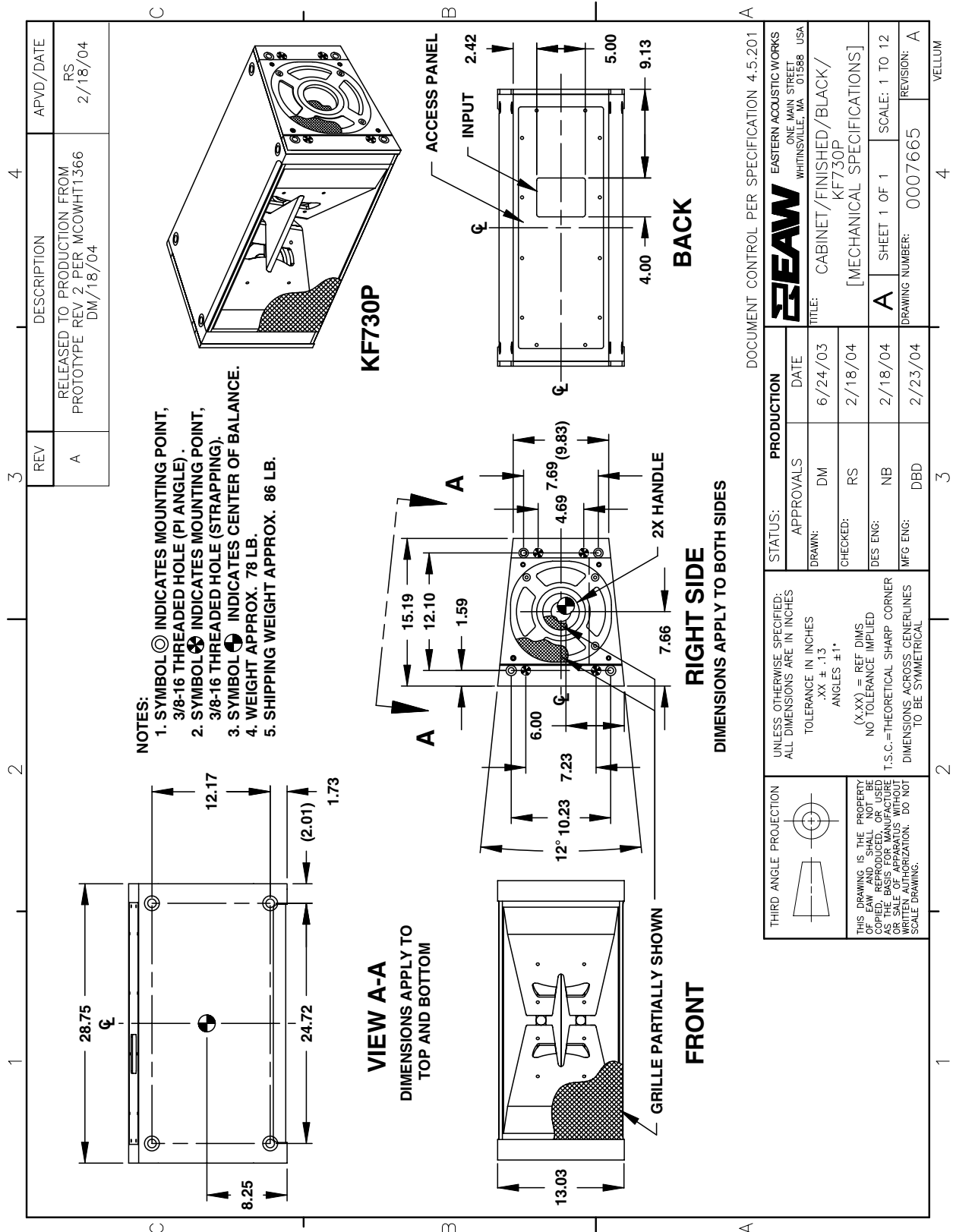

PERFORMANCE DATA See NOTES GRAPHIC DATA Notes for details

Frequency Response: Processed Bi-amplified

LF = green MF/HF = orange Complete = blue

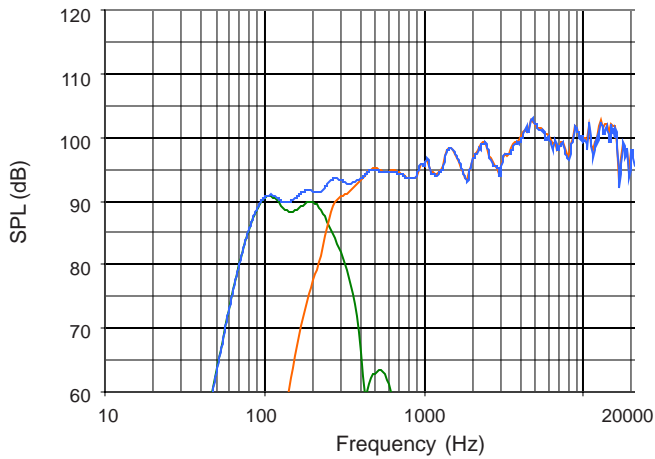

Frequency Response: Unprocessed

LF = green MF/HF = orange

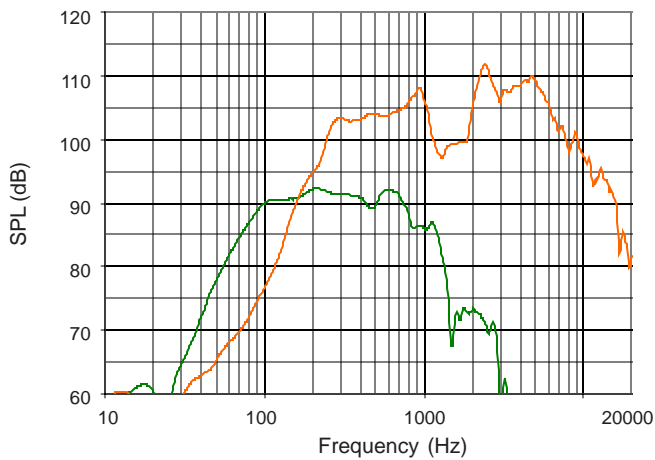

Frequency Response: Digital Signal Processor

LF = green MF/HF = orange

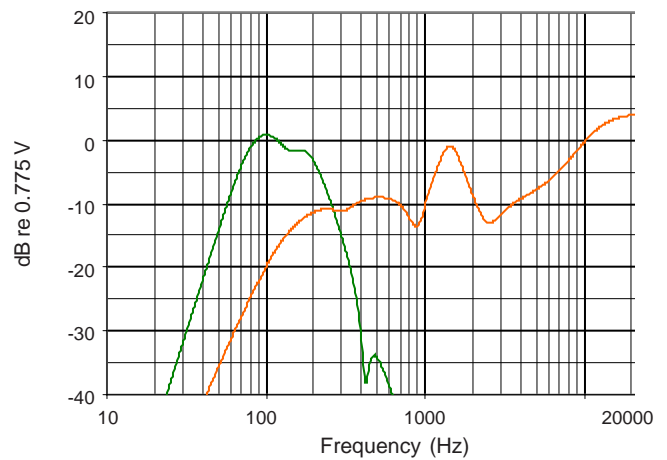

Impedance Magnitude

LF = green MF/HF = orange

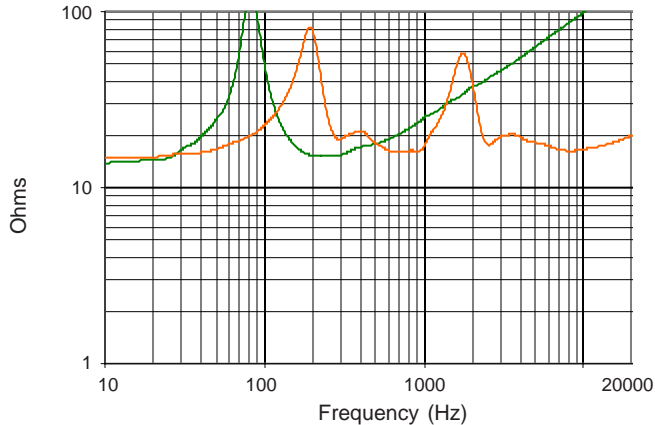

Beamwidth (-6 dB SPL Points)

Horizontal = orange Vertical = black

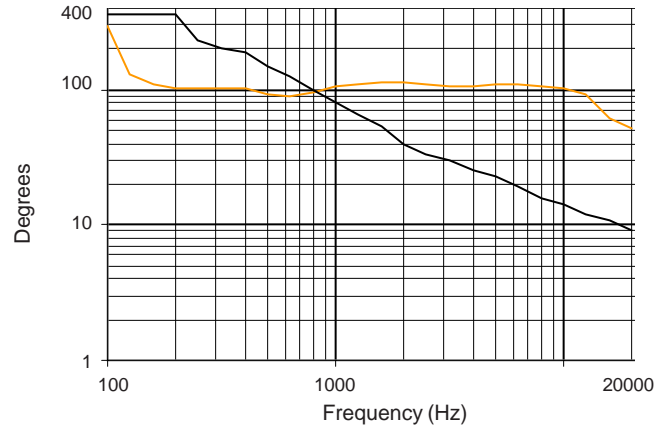

INPUT PANEL

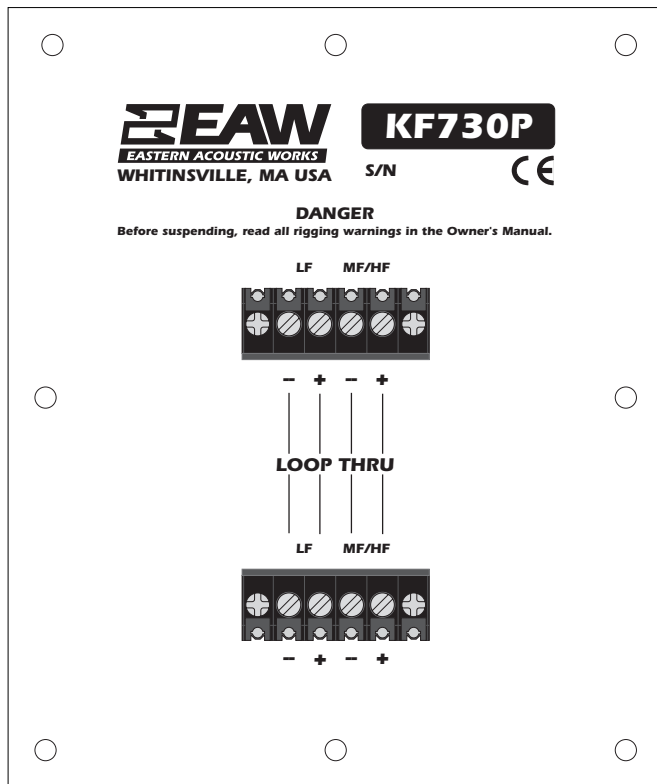

SIGNAL DIAGRAM

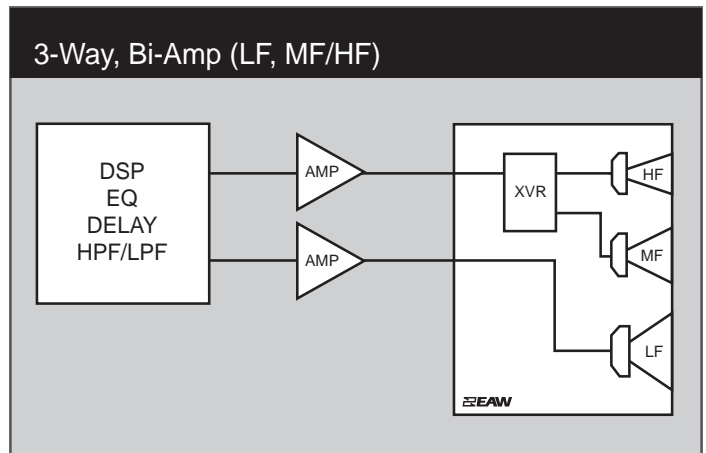

LEGEND

- DSP:** User-supplied Digital Signal Processor for EQ, crossover, and delay.
- HPF:** High Pass Filter for crossover or Recommended High Pass Filter.
- LPF:** Low Pass Filter for crossover.
- LF/MF/HF:** Low Frequency / Mid Frequency / High Frequency.
- PWR AMP:** User-supplied Power Amplifier.
- XVR:** Passive LPFs, HPFs, and EQ integral to the loudspeaker.

NOTES

TABULAR DATA

1. **Primary Measurement/Data Processing System:** FChart: proprietary EAW software.
2. **Secondary Measurement System:** Brüel & Kjær 2012.
3. **Microphone Systems:** Earthworks M30; Brüel & Kjær 4133
4. **Measurements:** Dual channel FFT; length: 32 768 samples; sample rate: 48 kHz; logarithmic sine wave sweep.
5. **Measurement System Qualification** (includes all uncertainties): SPL: accuracy +/-0.2 dB @ 1 kHz, precision +/-0.5 dB 20 Hz to 20 kHz, resolution 0.05 dB; Frequency: accuracy +/-1 %, precision +/-0.1 Hz, resolution the larger of 1.5 Hz or 1/48 octave; Time: accuracy +/-10.4 µs, precision +/-0.5 µs, resolution 10.4 µs; Angular: accuracy +/-1°, precision +/-1°, resolution 1°.
6. **Environment:** Measurements time-windowed and processed to eliminate room effects, approximating an anechoic environment. Data processed as anechoic or fractional space, as noted.
7. **Measurement Distance:** 7.6 to 8.0 m. Data is referenced to other distances using the Inverse Square Law.
8. **Volts:** Measured rms value of the test signal.
9. **Watts:** Per audio industry practice, "loudspeaker watts" are calculated as voltage squared divided by rated nominal impedance. Thus, these are not True Watt units of energy as defined by International Standard.
10. **SPL:** (Sound Pressure Level) Equivalent to the average level of a signal referenced to 0 dB SPL = 20 microPascals.
11. **Subsystem:** This lists the transducer(s) and their acoustic loading for each passband. Sub Bass = Subwoofer, LF = Low Frequency, MF = Mid Frequency, HF = High Frequency.
12. **Operating Mode:** User selectable configurations. Between system elements, a comma (,) = separate amplifier channels; a slash (/) = single amplifier channel. DSP = Digital Signal Processor. IMPORTANT: To achieve the specified performance, the listed external signal processing must be used with EAW-provided settings.
13. **Operating Range:** Range where the processed Frequency Response stays within -10 dB SPL of the power averaged SPL within this range; measured on the geometric axis. Narrow band dips are excepted.
14. **Nominal Beamwidth:** Design angle for the -6 dB SPL points, referenced to 0 dB SPL as the highest level.
15. **Axial Sensitivity:** Power averaged SPL over the Operating Range with an input voltage that would produce 1 W at the nominal impedance; measured with no external processing on the geometric axis, referenced to 1 m.
16. **Peak Sensitivity:** Highest axial SPL measured within the 20 Hz to 20 kHz bandpass with an input voltage that would produce 1 W at the nominal impedance; measured with no external processing on the geometric axis, referenced to 1 m.
17. **Nominal Impedance:** Selected 4, 8, or 16 ohm resistance such that the minimum impedance point is no more than 20% below this resistance over the Operating Range.
18. **Accelerated Life Test:** Maximum test input voltage applied with an EIA-426B defined spectrum; measured with recommended signal processing and Recommended Protection Filter.
19. **Calculated Axial Output Limit:** Highest average and peak SPLs possible during the Accelerated Life Test. The Peak SPL represents the 2:1 (6 dB) crest factor of the Life Test signal.
20. **Recommended High Pass Filter:** This should be used to help protect the loudspeaker from excessive input signal levels below the Operating Range.

GRAPHIC DATA

1. **Resolution:** To remove insignificant fine details, 1/12 octave cepstral smoothing was applied to acoustic frequency response and 1/3 octave cepstral smoothing was applied to the beamwidth and impedance data. Other graphs are plotted using raw data.
2. **Frequency Responses:** The variation in acoustic output level with frequency for a constant input signal of 2 volts (4 ohm nominal impedance), 2.83 volts (8 ohm nominal impedance), or 4 volts (16 ohm nominal impedance) referenced to a distance of 1 m. For processed systems, this applies where the processor gain is 0 dB in the Processor Frequency Response graph.
3. **Processor Response:** The variation in output level with frequency for a constant input signal of 0.775 V = 0 dB reference.
4. **Beamwidth:** Average angle for each 1/3 octave frequency band where, starting from the rear of the loudspeaker, the output first reaches -6 dB SPL referenced to 0 dB SPL as the highest level. This method means the output may drop below -6 dB SPL within the beamwidth angle. Referenced to 20 m.
5. **Impedance:** Variation in impedance magnitude, in ohms, with frequency without regard to voltage/current phase. This means the impedance values may not be used to calculate True Watts (see 9 above).